

Müşteri Customer**Müşteri Ref. No.** Customer Ref. No.**Sipariş No.** Order No.

Ürün Product	3 Fazlı, tam kapalı, fan soğutmalı, sincap kafesli asenkron motor 3 Phase, totally enclosed, fan-cooled, squirrel cage induction motor		
Ürün Kodu Product Code	3M0SG4E-31MD20AT0		
Motor Tipi Motor Type	3MGS 315MD2		
Kurulum Düzeni Mounting	IM B3		
Klemens Kutusu Konumu Terminal Box Pos.	Üstte on Top		
Verim Sınıfı Efficiency Class	IE4 verim sınıfı IE4 efficiency class		
Anma Gücü Rated Output P_N	200	kW	
Kutup Sayısı Pole Number	2		
Frekans Rated Frequency f_N	50	Hz	
Anma Gerilimi Rated Voltage U_N	400 / 690	V	(D / Y)
Devir Rated Speed n_N	2983	rpm	
Anma Akımı Rated Current I_N	325,2 / 186,6	A	(D / Y)
Anma Momenti Rated Torque T_N	640,6	Nm	
Eylemsizlik Momenti Inertia Moment J	2,30	kg.m ²	
Yük Durumu Load Characteristics	4/4 100% load	3/4 75% load	2/4 50% load
Verim Efficiency η	96,5 %	96,7 %	96,3 %
Güç Faktörü Power Factor $\cos\phi$	0,92	0,89	0,86
Kalkış Akımı Locked Rotor Current I_A/I_N	8,0		
Kalkış Momenti Locked Rotor Torque T_A/T_N	2,4		
Devrilme Momenti Breakdown Torque T_K/T_N	3,1		
Koruma Derecesi Protection Degree	IP 55		
Yalıtım Sınıfı Insulation Class	F	(155°C)	
Sıcaklık Artış Sınıfı Temp. Rise Class	B	(80K)	
Ortam Sıcaklığı Ambient Temp.	-20°C +40°C		
Rakım Altitude	1000	m.a.s.l.	
Soğutma Yöntemi Cooling Method	IC 411		
Gürültü Düzeyi Sound Pressure Level	80	dB	
Titreşim Sınıfı Vibration Class	Derece A	Grade A	
Çalışma Tipi Duty Type	S1		
Servis Faktörü Service Factor	1		
Motor Dönüş Yönü Direction of Rotation	Saat yönü veya saat yönünün tersi		CW or CCW
Yaklaşık Rotor Ağırlığı Appx. Rotor Weight	320	kg	
Yaklaşık Motor Ağırlığı Appx. Motor Weight	1408	kg	
Rulmanlar Bearings	ÖN DE	ARKA NDE	
	6316 C3	6316 C3	
Yeniden Yağlama Periyodu Relubrication Period	2500h	2500h	
Yağ Miktarı Grease Amount	33g	33g	
Yağ Cinsi Grease Type	Shell Alvania Rt3		

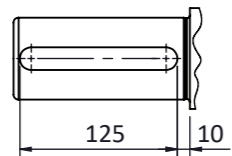

Klemens Kutusu 90° Döndürülebilir.
Terminal Box Can Be Turned 90°

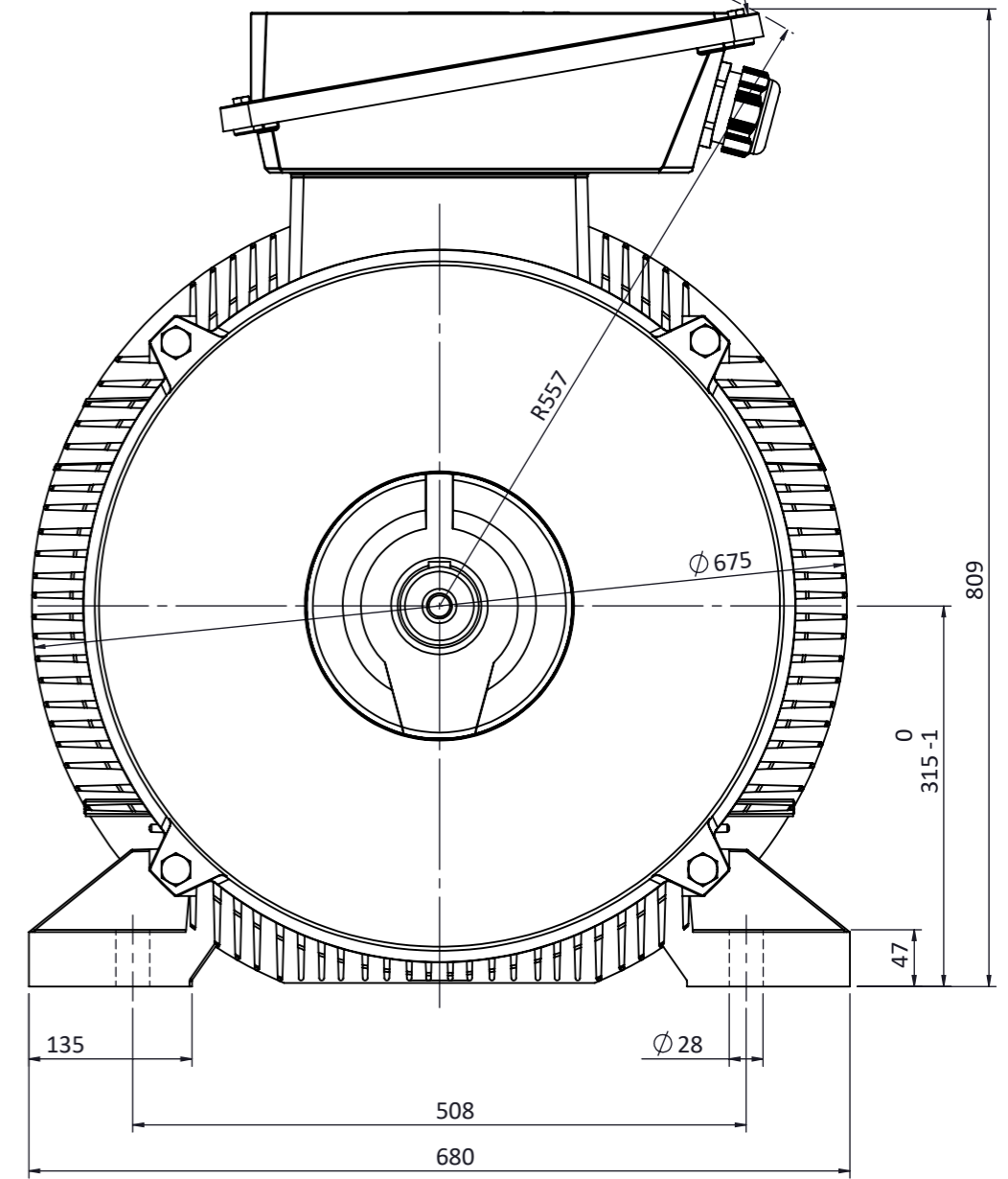
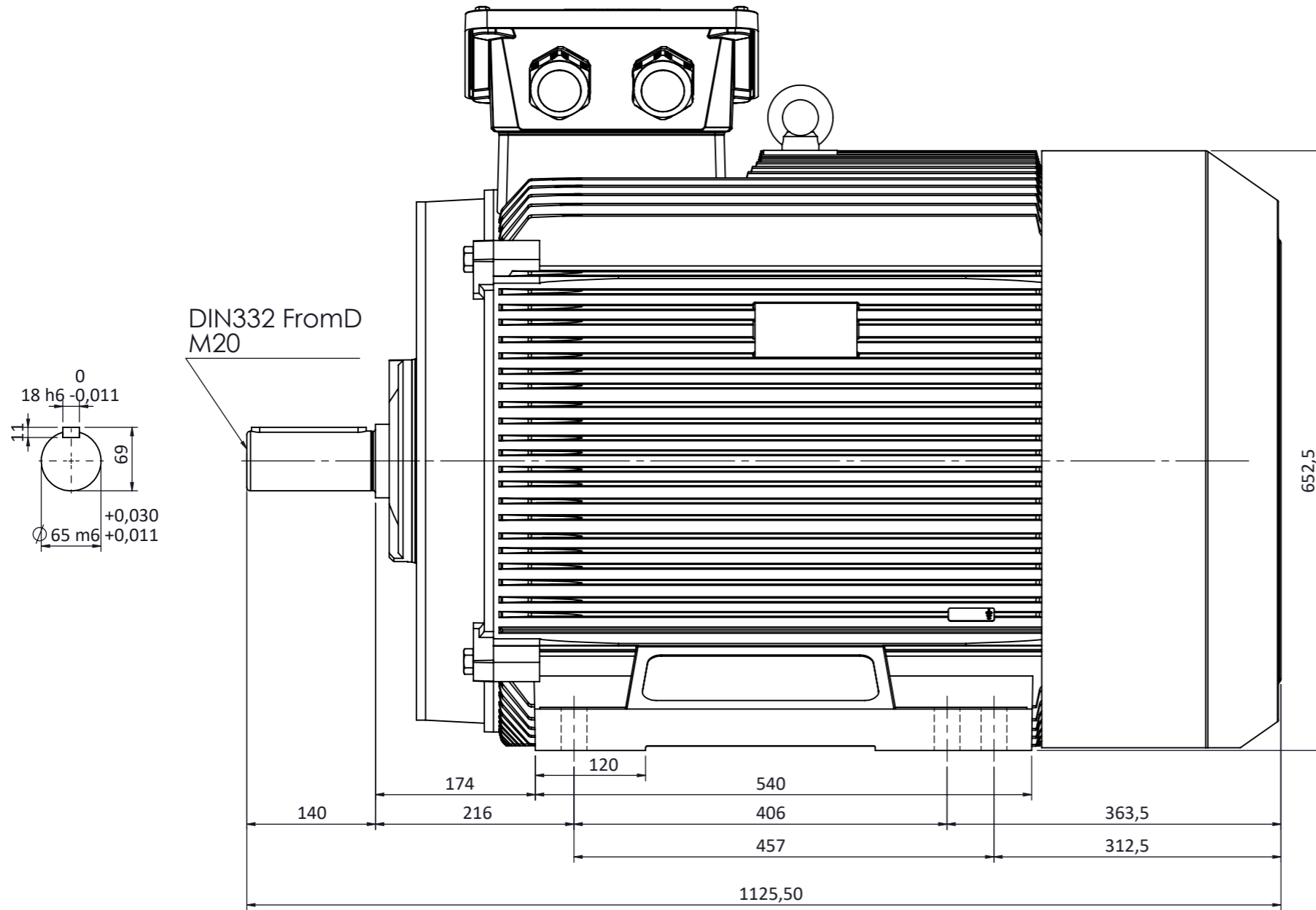

NOT:

	TARİH / DATE	İSİM / NAME	İMZA / SIGN.	MALZEME / MATERIAL				
ÇİZEN / DRAWN	06.09.2017	Nur YAYDEMİR		-----				
KONT. / CHECK	06.09.2017	Mustafa ATAK						
ONAY / APPR.	06.09.2017	Şerif ÖZTÜRK						
	PARÇA ADI / PART NAME			ADET QUANTITY	SERTLİK HARDNESS	KÜTLE MASS Kg	ÖLÇEK SCALE	RESİM NO DRAWING NO
	315MS B3 (2 Kutup/Pole)						1:6 A3	G-315MS 2 B3-T
OMEGA Motor Sanayi A.Ş.'nin izni olmadan üçüncü şahıslara verilemez. OMEGA imzalı ve mühürlü olmayan resimler geçersizdir. Bütün hakları saklı ve gizlidir.								SERİ NO: Q315MS 2 B3